

T E C H N I C A L R E P O R T

TROUBLE SHOOTING

Water Pump

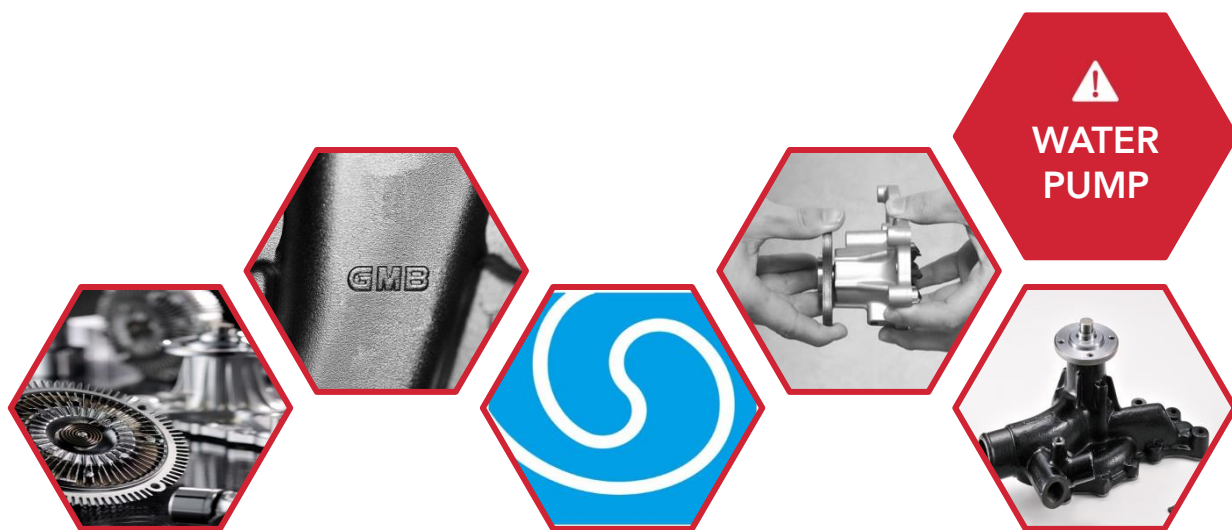

The Function of the Water Pump

Coolant Flow

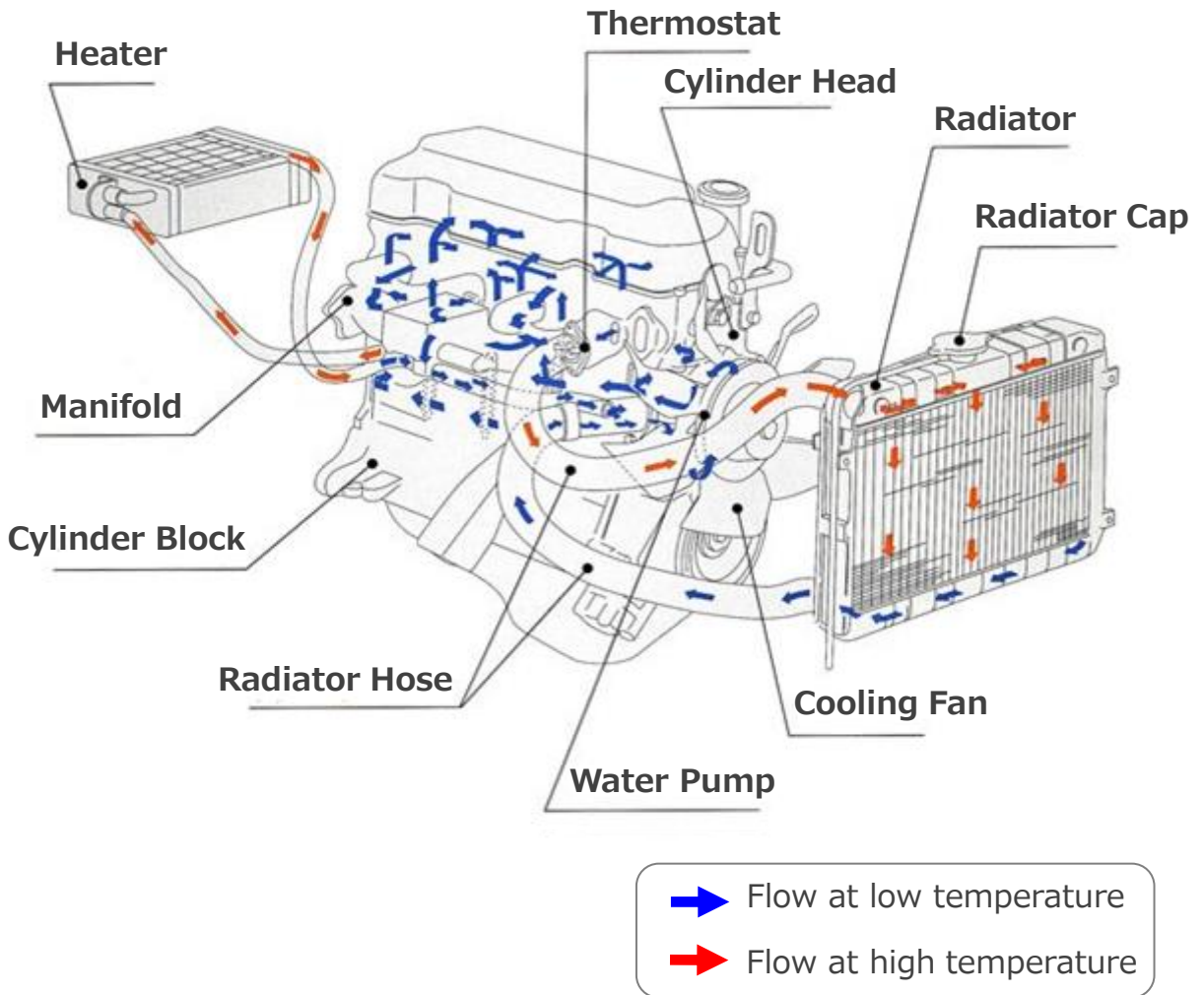

Water Pump is integral parts of cooling system and has important roll to circulate the coolant through engine block water jacket and radiator.

Engine heated high temperature coolant is cooled off through radiator and circulated into engine block water jacket.

Water Pump is positioned between engine and radiator, and water pump is driven by belt pulley system, timing belt or fan belt to circulate coolant forcibly.

Structure and Mechanism of Water Pump

The exploded view of an water pump

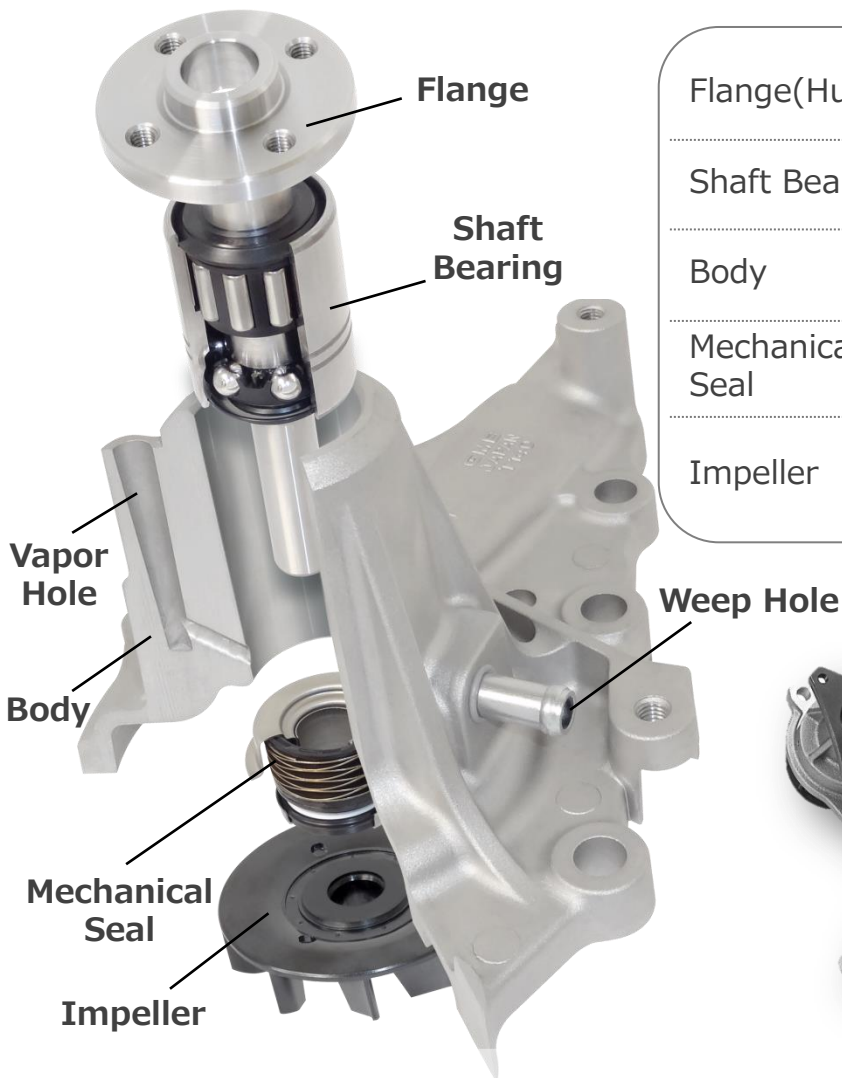

Flange(Hub)	Pulley and/or fan clutch are mounted onto the flange.
Shaft Bearing	There are Ball/Ball and Ball /Roller types.
Body	Aluminum with Die-Cast, Gravity-Cast and Cast-Iron
Mechanical Seal	Maintain rotor being closed tightly
Impeller	There are either ,pressed steel, cast-iron or resin type.



Crank Shaft rotary power drives impeller rotation through water pump pulley and bearing shaft.

The impeller rotation drives coolant into water jacket using centrifugal force and makes coolant circulate.

Coolant filled pump room and water pump bearing is isolated by mechanical seal.

Mechanical seal is dynamic rotation seal type and is always required to rotate in lubricated condition. The approached and lubricated liquid turns into vapor, The weep hole in body has a mechanism to discharge the vapor out of the hole.

While engine is running, water pump flange belt or timing belt continues to drive bearing shaft at higher RPM than engine RPM Therefore, high durability is required for water pump.

Replacing Water Pump

Precaution in Replacing Water Pump

Replacement should be handled by specialist

『If handled by non-specialist, it may cause failure of water pump itself and also other failures apart from water pump』

Please be sure of water pump car model, production year, OE parts number

『Installing water pump of different part number causes failure or overheating』

Do not shock water pump

『Water Pump composed of precision parts of bearing, mechanical seal etc. If water pump is struck by a hammer or is dropped, it may cause leakage or damage to bearing』

Do not install water pump while engine is heated

『Heated coolant flows out to cause burns Install water pump after engine is cooled down completely』

Do not refill cold water or coolant while engine is heated

『Sudden temperature change will damage mechanical seal and engine parts』

Do not start engine without coolant

『Mechanical seal will be damaged and it causes leakage』

While engine is running, do not stand close to fan coupling or in rotational direction of fan

『While engine is running and if rotating parts such as fan were damaged, those parts will scatter around and could cause serious injury』

Be sure there is no leakage in other parts, radiator, radiator hose, heater core etc. other than water pump

『Leakage occurs in other parts than water pump』

Check fan, fan coupling, pulley fan belt, radiator cap, thermostat etc.

『Abnormal noise and failure in cooling system can arise in parts other than water pump』

When you replace timing belt driven type of water pump, replace timing belt and tensioner bearing at same time

『Abnormal noise and failure in cooling system can arise in parts other than water pump』

Replacing Water Pump

Precautions

■ Do not dry turn water pump

Do not turn the flange or pulley while mechanical seal contact surface is in dry condition. Turning in dry condition may cause damage to carbon and make squealing noise.

In dry condition, it may make squealing noise but it will stop when coolant lubricates contact surface of mechanical seal after water pump is installed to engine.

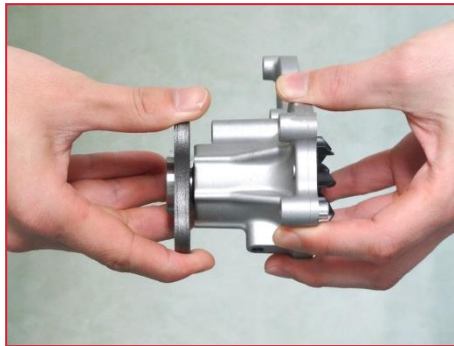

■ Do not apply liquid sealant to O ring

By applying liquid sealant for O ring type seal, excess amount of liquid sealant mixes with coolant inside water channel and intrude into mechanical seal contact surface which will cause leakage.



■ Inspection on Belts

When replacing water pump, inspect and adjust pulley belt, timing belt. If belt is cracked or foreign material or oil is adhering to belts or belt tension is insufficient, then abnormal noises are likely to be produced.

Replacing Water Pump

Procedure

1

Flush radiator and engine replacing coolant, and remove dirt, rust deposits out of cooling system in installed condition of old water pump.

Foreign material intrudes into mechanical seal and it causes leakage

2

Remove old water pump, completely clean remaining gaskets or dirt from mounting surface.

If cleaning is incomplete, it causes to leak out of mounting surface

3

Apply liquid sealant lightly and evenly on both sides of new gasket. Do not apply sealant for O ring or metal gasket.

Excess sealant usage allows seal agent to enter into coolant. It causes leakage in early stage

4

Install new water pump and tighten mounting bolts in diagonal pattern with car manufacturer's specified torque evenly.

Excessively tightening bolts causes mounting bolt hole damaged and causes leakage

5

If the water pump is the type to be assembled with fan clutch, and if you find installation wobbling or damage, replace the parts.

Increased vibration causes fracture on bearing, body and or flange

6

Install belt on water pump pulley and adjust tension to the specified value by car manufacturer.

If excessive load is applied, water pump body and bearing will have excess load which leads to early stage fracture

7

Refill radiator with new coolant and ensure there is no leakage. Do not recycle old coolant Use new coolant with concentrations and volume specified by car manufacturer.

Abnormal noise and failure in cooling system can arise in parts other than water pump.

8

Bleed the air completely to ensure the radiator and its reservoir tank are filled with coolant volume specified by car manufacturer.

At the end, check there is no leakage, no abnormal noise in any places. Now the replacement is complete.

If you start engine with insufficient coolant, it will cause water circulation failure and abnormal wear of mechanical seal

Failure Cause and Prevention

Leakage –Weep Hole-

Location	Symptom	Cause
Body weep hole	Rough contact surface of Mechanical seal	<ul style="list-style-type: none"> • Coolant degradation • Foreign material(dirt. sludge) intruded
	Foreign material adhering to contact surface of mechanical seal	<ul style="list-style-type: none"> • Coolant degradation • Excess liquid sealant application allows sealant to enter into water channel and mix with coolant and it intrude into mechanical seal
	Mechanical seal fractured, burned	<ul style="list-style-type: none"> • Driving with insufficient coolant
	Mechanical seal fractured	<ul style="list-style-type: none"> • Pulley run-out • Insufficiently and unevenly tightened bolts.
	Early stage matching of mechanical seal contact surface	<ul style="list-style-type: none"> • Internal pressure difference causes drip and generates vapor

Vapor generated in early stage of Installation will stop after matching on contact surface of mechanical seal

Prevention

- Regular coolant maintenance
- Fully flush when replacing coolant
- Apply appropriate amount of liquid sealant evenly
- Refill coolant
- Tighten mounting bolts evenly in an diagonal pattern
- Install belts with proper tension

Failure Cause and Prevention

Leakage –Mounting Surface-

Location	Symptom	Cause
Mounting Surface	Foreign material adhering to mounting surface	<ul style="list-style-type: none"> Contamination on engine mounting surface caused foreign material to intrude
	Liquid sealant is not applied for supplied gasket	<ul style="list-style-type: none"> Liquid sealant is not applied
	Improper installation	<ul style="list-style-type: none"> Chip, deformation on mounting surface Tightening torque failure Applied sealant on O ring, metal gasket
	Gasket fractured, deformed	<ul style="list-style-type: none"> During transportation, handling, fractured and deformed

Prevention

- Clean engine mounting surface of any remaining gasket /sealant without causing damage on mounting surface
- Apply liquid sealant on both sides of supplied gasket (Apply liquid sealant lightly and evenly on both sides of our supplied paper gasket)
However, do not apply liquid sealant for O ring, metal gasket
- Tighten mounting bolts with manufacturer specified torque evenly in an diagonal pattern

Failure Cause and Prevention

Noise

Location	Symptom	Cause
Water pump area	Bearing noise 「Rumbling」	<ul style="list-style-type: none"> • Coolant intrusion due to mechanical seal failure • Excess Belt Tension • Vibration by run-out of pulley/fan
	Mechanical seal noise 「Whining」	<ul style="list-style-type: none"> • Seal contact area is dry
	Belt noise 「Squeak」	<ul style="list-style-type: none"> • Belt degradation, tension performance degraded

Prevention

- Regular coolant maintenance
- Regular maintenance of belt tensioner
- Regular check for belt degradation

Location	Symptom	Cause
Body Fractured	Corrosion due to cavitation	<ul style="list-style-type: none"> • Corrosion due to coolant deterioration (oxidation etc.)
	Mounting bolts hole fractured	<ul style="list-style-type: none"> • Bolts were tightened with excessive torque

Prevention

- Regular coolant maintenance
- Fasten mounting bolts with manufacturer specified torque evenly in an diagonal pattern

Failure Cause and Prevention

Overheat

Failure	Symptom	Cause
Overheat	Impeller idling	<ul style="list-style-type: none">• Coolant Frozen
	Impeller broken, corroded	<ul style="list-style-type: none">• Corrosion by coolant deterioration (oxidation)
	Corrosion by cavitation	<ul style="list-style-type: none">• Corrosion by coolant deterioration (oxidation)

Prevention

- Use specified and suitable coolant for cold districts
- Regular coolant maintenance
- Adjust Belt tension to the specification.
- Replace degraded belts

Specimen Problems

1. Leakage out of weep hole

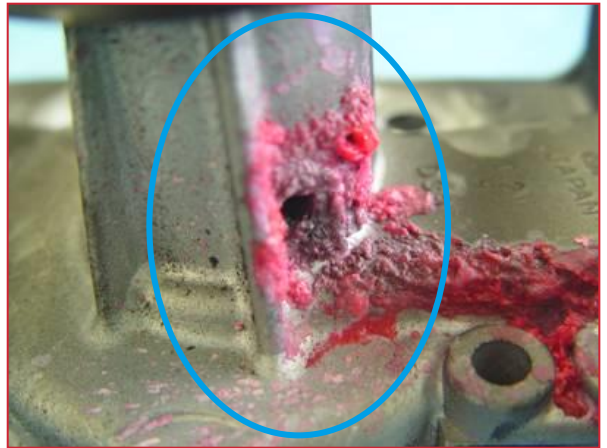

■ Cause 1. Wear by Coolant

Resulting from sludge or rust from metallic corrosion carried by coolant intruding into mechanical seal surface and abrading sealing surface so sealing performance decreases



□ Prevention

- Coolant needs regular maintenance
- Cooling system should be flushed completely at replacement.

Specimen Problems

Leakage out of weep hole

■ Cause 2. Usage of excess liquid sealant

Excess amount of liquid sealant mixes with coolant and intrudes between opposing sides of mechanical seal stopping full seal being made and causing leakage



Prevention

- Liquid sealant must be applied evenly to water pump gasket surface.
However, do not apply liquid sealant for O ring and metal gasket.

Specimen Problems

Leakage from Mounting Surface



■ Cause 1. Contamination on mounting surface(Sealant grime etc.)

Prevention

- Ensure mounting surface is free from remaining gasket /sealant without causing damage on mounting surface

■ Cause 2. Liquid sealant is not applied

Prevention

- Apply sealant on both side of supplied gasket

■ Cause 3. Applying sealant on supplied O ring, Metal gasket

Prevention

- Do not apply liquid sealant on O ring type seal.

■ Cause 4. Improper installation

Prevention

- Tighten mounting bolts using manufacturer's specified torque evenly in a diagonal pattern

Specimen Problems

Noise

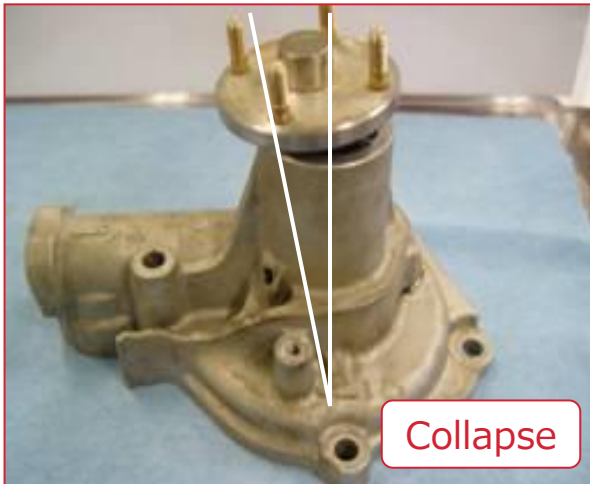

■ Cause 1. Mechanical seal failure caused coolant intrude into bearing

Prevention

- Regular coolant maintenance

■ Cause 2. Excess vibration by other installed parts(pulley/fan)

Prevention

- Check fully abrasion condition, run-out of pulley/fan and replace them if found abnormal

■ Cause 3. Excess belt tension

Prevention

- Keep belt tension within the values specified by car manufacturer

Specimen Problems

Overheat

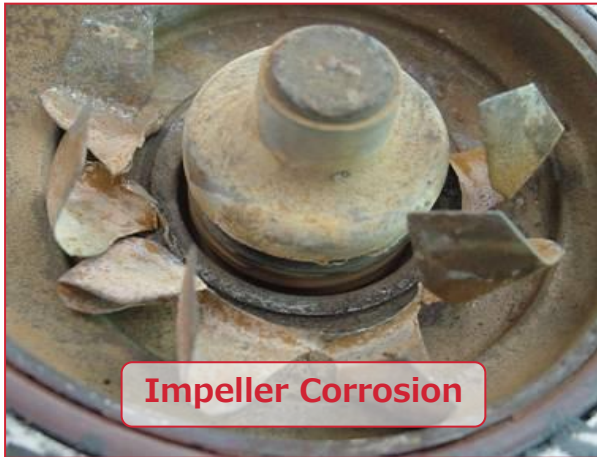

- Cause 1. Coolant Frozen
- Cause 2. Corrosion due to coolant deterioration (oxidation etc.)
- Cause 3. Prolonged use of coolant exhausts the rust preventive chemicals and ethylene glycol which are main element of antifreeze turns into formic acid

Prevention

- Use coolant specified and suitable for cold districts.
Do not recycle used coolant.
Use a good quality coolant with concentration corresponding to respective area climate
- Regular maintenance of coolant.
Before replacing water pump, replace coolant in radiator and engine block water jacket and fully flush